

Varenummer: 4320000601  
Beskrivelse: Rota-fix spændelement A 60x90  
Rustfast stål

## Mål

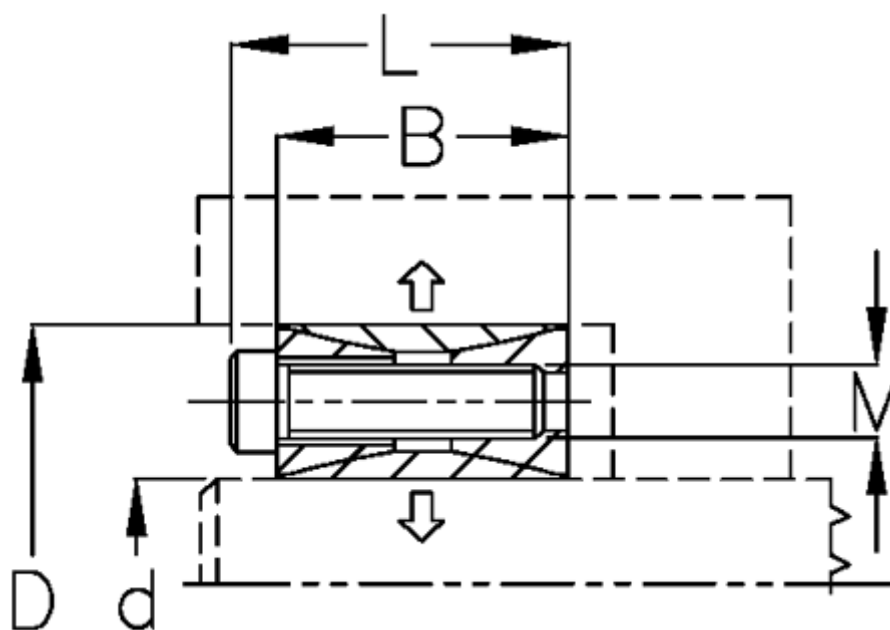

B mm	= 24
d H8 mm	= 60
D mm	= 90
F kN aksialkraft	= 51.3
L mm	= 32
M mm	= M8
Overfladeruhed	= R? ? 3.2 $\mu$ m
P N/mm <sup>2</sup> fladetryk på aksel/nav	= 45

T Nm drejningsmoment	= 1500
Tolerance	= Aksel k11-h11, Nav M
Ts Nm boltetilspændingsmoment	= 21.4